











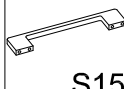

# SONIA

SZAFKA GÓRNA 30 / 60  
 SKRINKA HORNÁ 30 / 60  
 HÖNGESCHRANK 30 / 60  
 WALL UNIT 30 / 60  
 HAUT 30 / 60

|  |  |  |   |  |  |  |  |  |  |  |  |  |
|--|--|--|---|--|--|--|--|--|--|--|--|--|
|  |  |  |  |  |  |  |  |  |  |  |  |  |
| 8  | 8  | 8  | 1   | 1  | 2  | 8-10   | 4  | 2  | 2  | 4  | 2  | 4  |

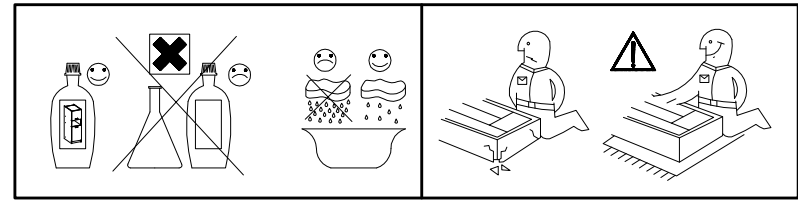
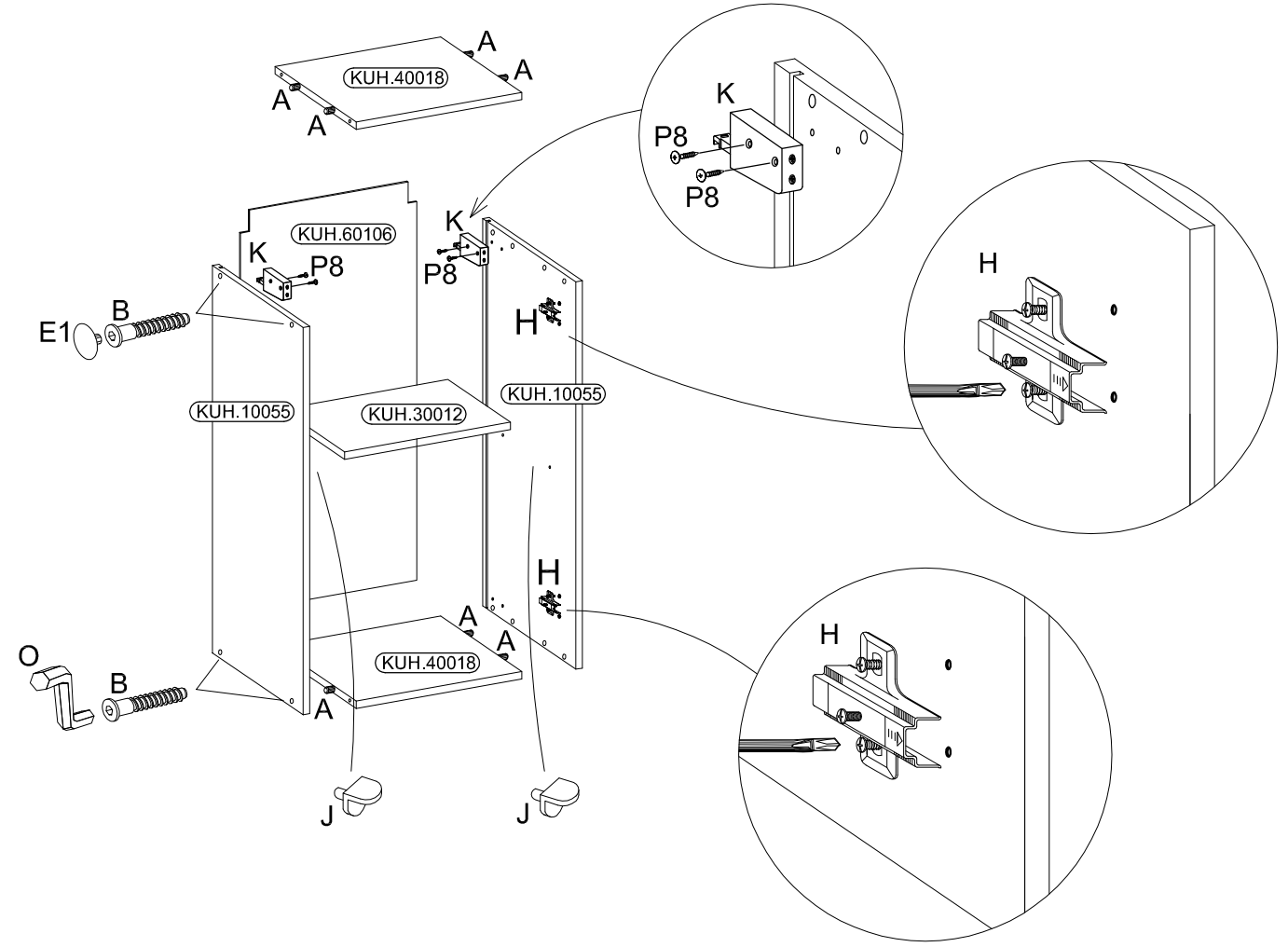
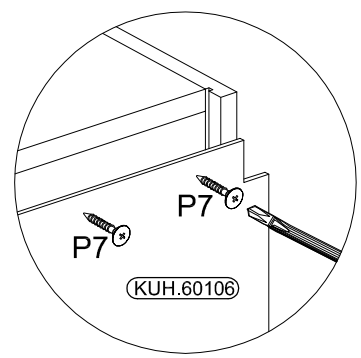
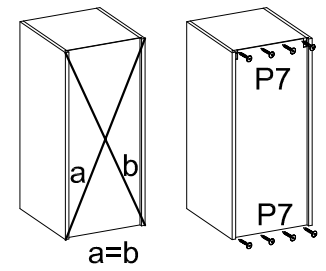
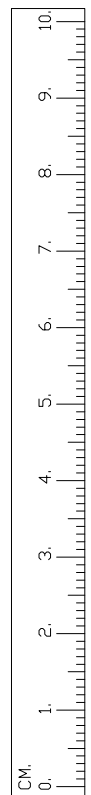
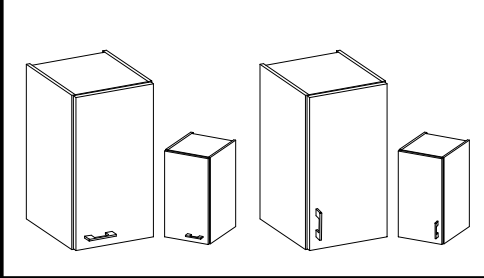

ISM-KUH-00839

# SONIA

SZAFKA GÓRNA 30 / 60  
SKRINKA HORNÁ 30 / 60  
HÖNGESCHRANK 30 / 60  
WALL UNIT 30 / 60  
HAUT 30 / 60

