

50 G-72 1F
50 ZL 1F BB
FRONT

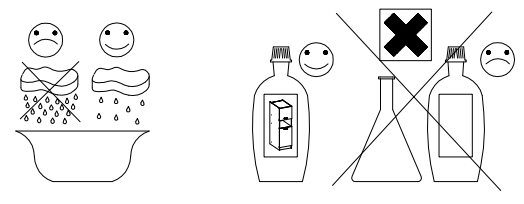

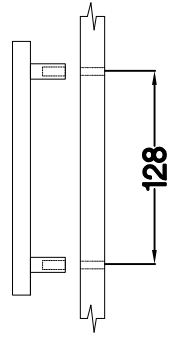

50 ZL 1F BB

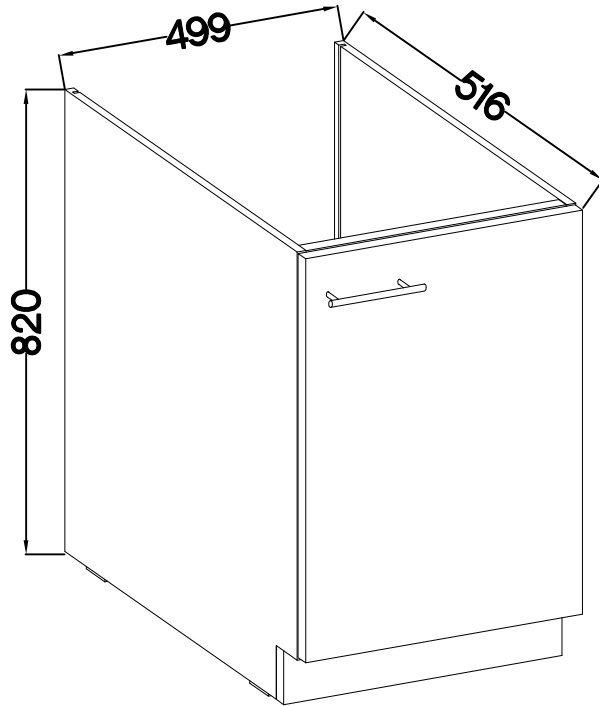

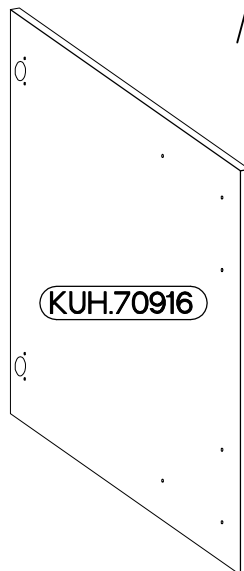
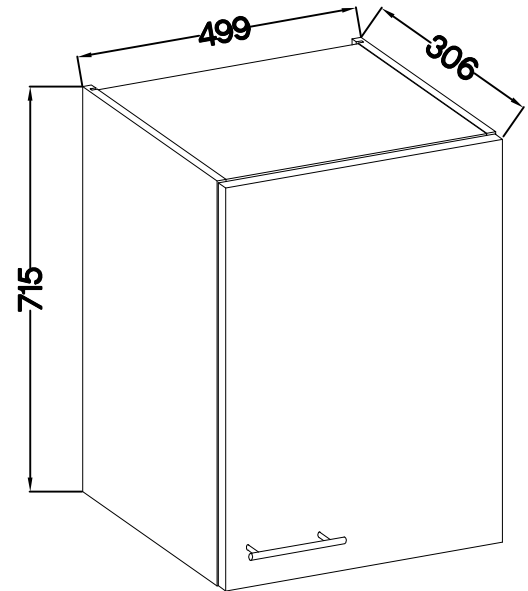
50 G-72 1F



M4x22mm	L=128mm
	
U	S
2	1

ISM-KUH-01641

1

50 G-72 1F

LEFT

RIGHT

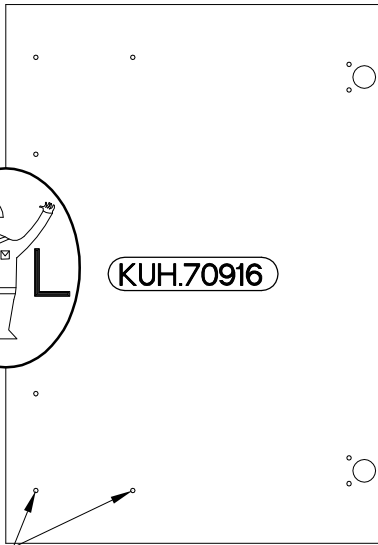
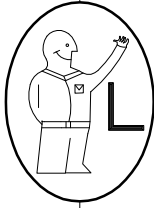
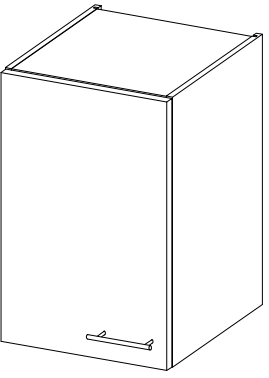

KUH.70916

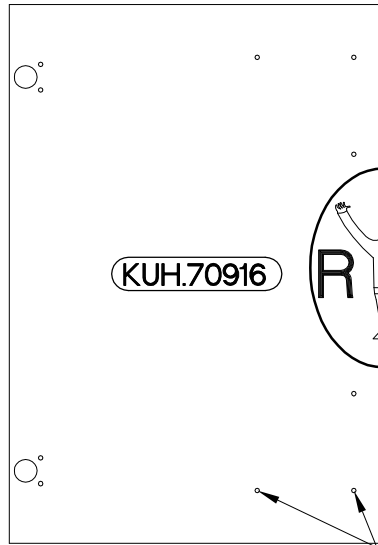

KUH.70916

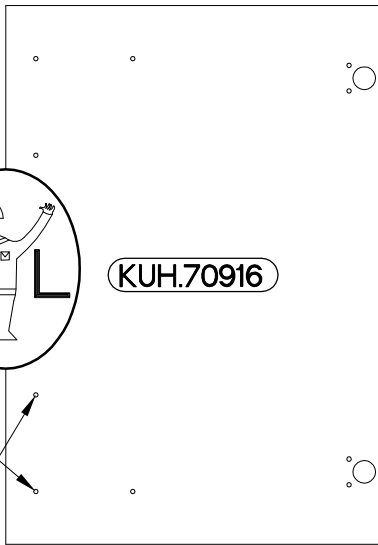
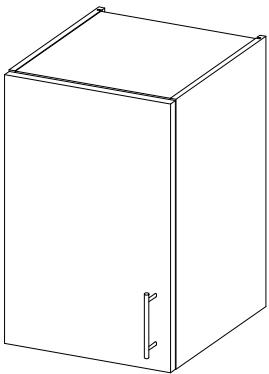
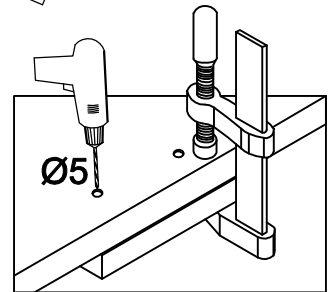
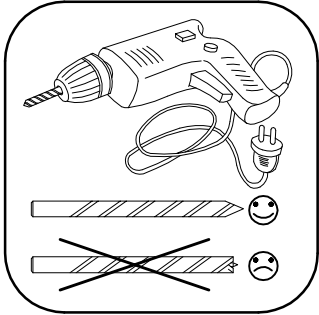
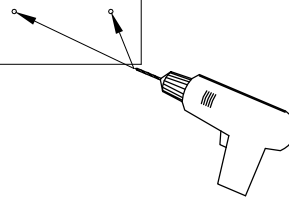
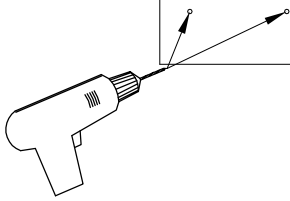
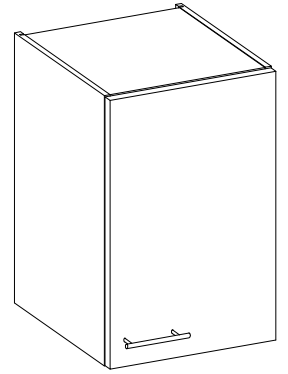

KUH.70916

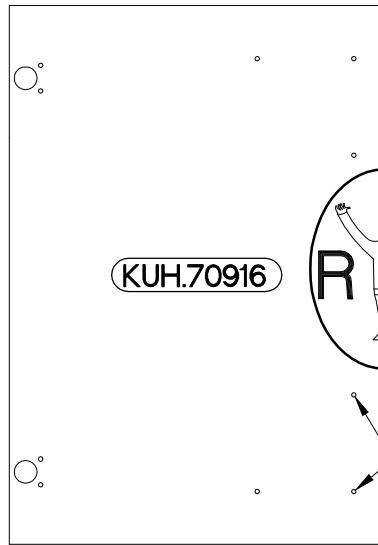

KUH.70916

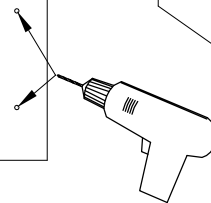
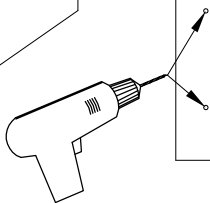
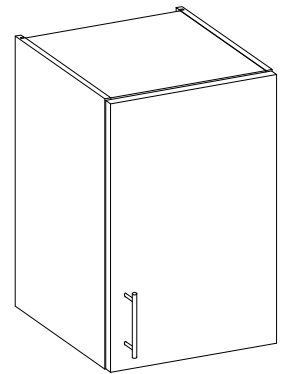

2

$\pm 35/0\text{mm}$	$\pm 3.5 \times 13\text{mm}$
[CD] HG	P5
2	4

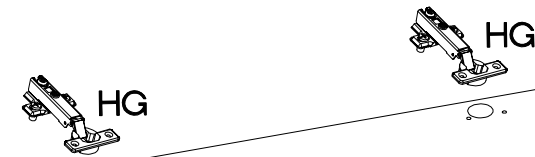

HG

HG

KUH.70916

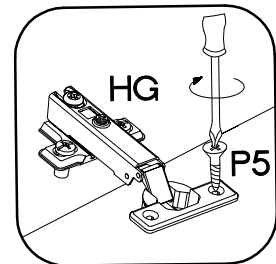

HG

P5

3

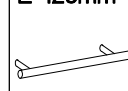
M4x22mm	L=128mm
 U	 S
2	1

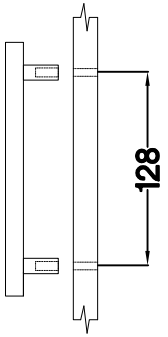
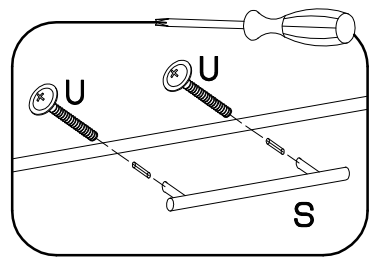
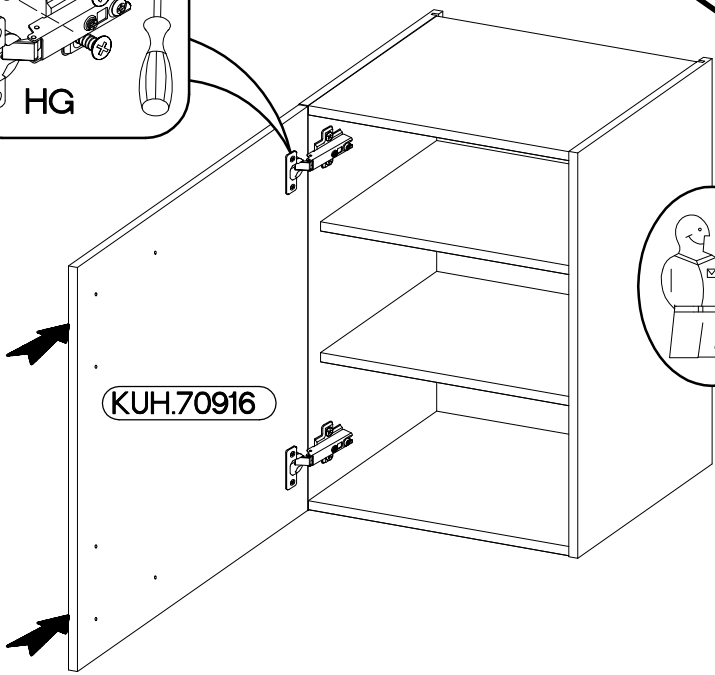
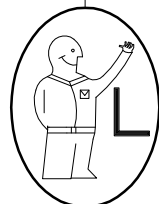
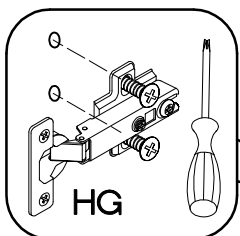
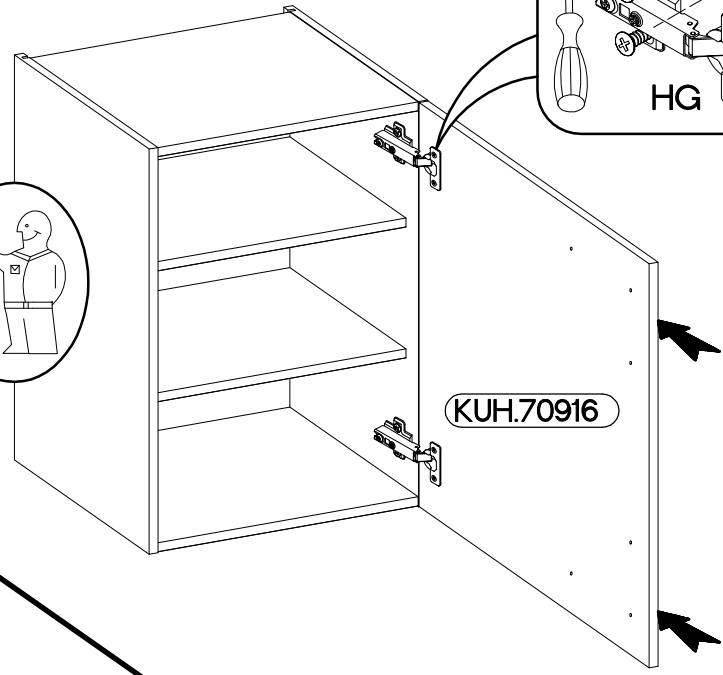
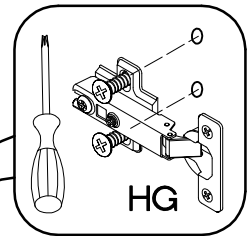
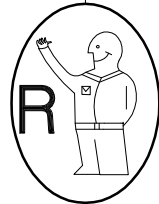

VARIANT HIGH GLOSS

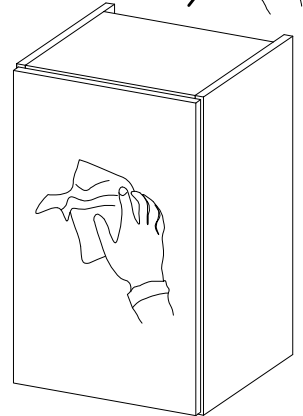
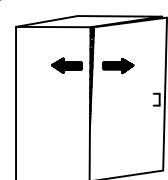
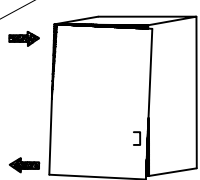
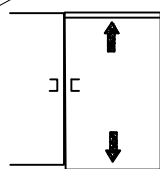
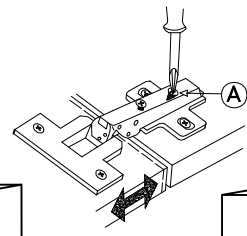
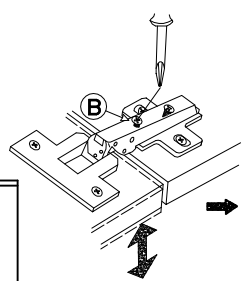
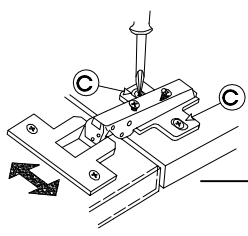
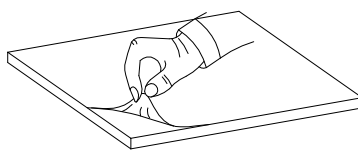
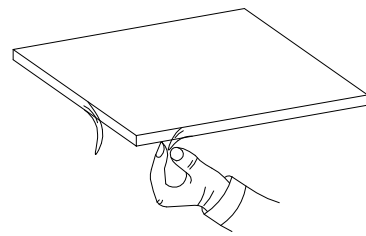

4 50 ZL 1F BB

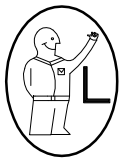

LEFT



RIGHT

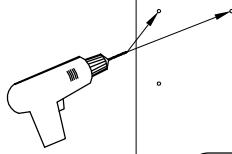
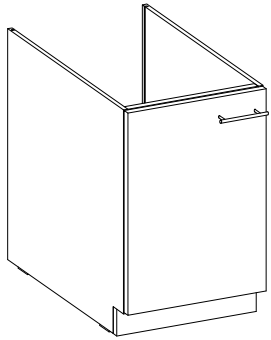

KUH.70916

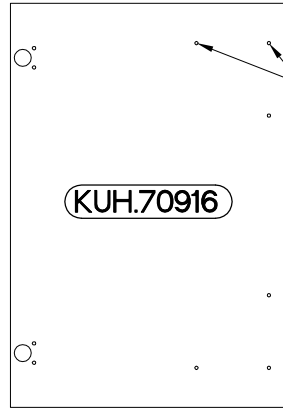

KUH.70916

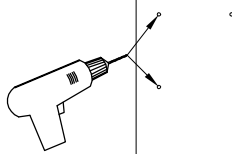
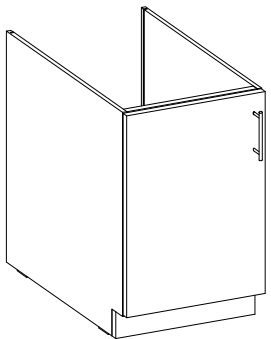
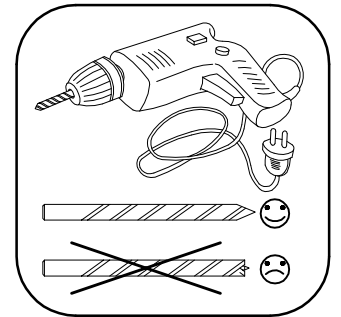
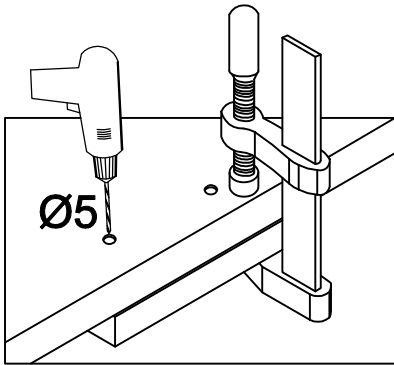
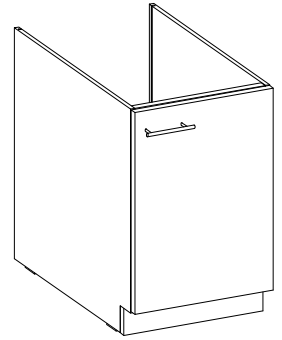



KUH.70916

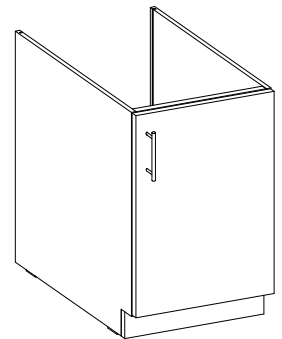

KUH.70916



5

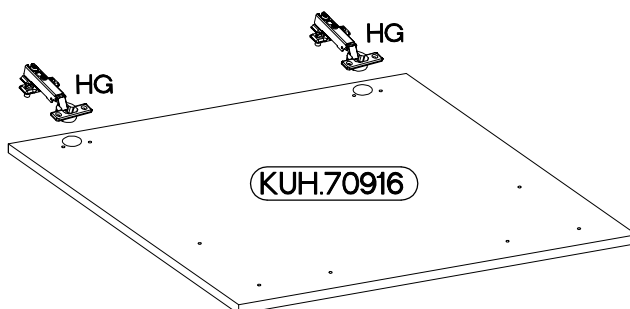

 †35/0mm [CD] HG 2	 †3.5x13mm P5 4
--	---

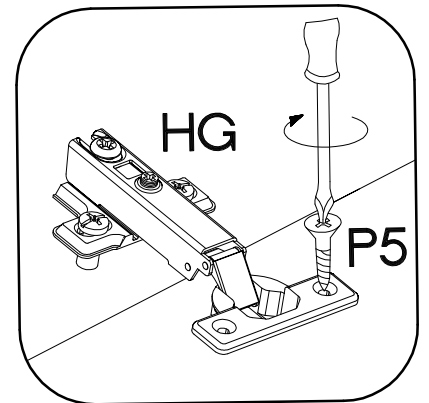

KUH.70916



6

M4x22mm  U 2	L=128mm  S 1
---	--

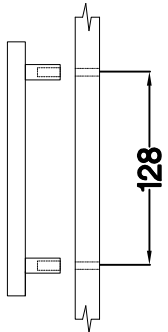
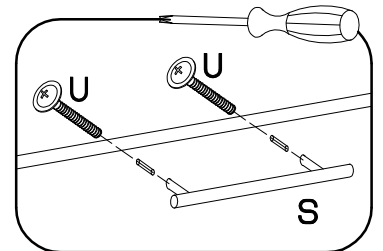
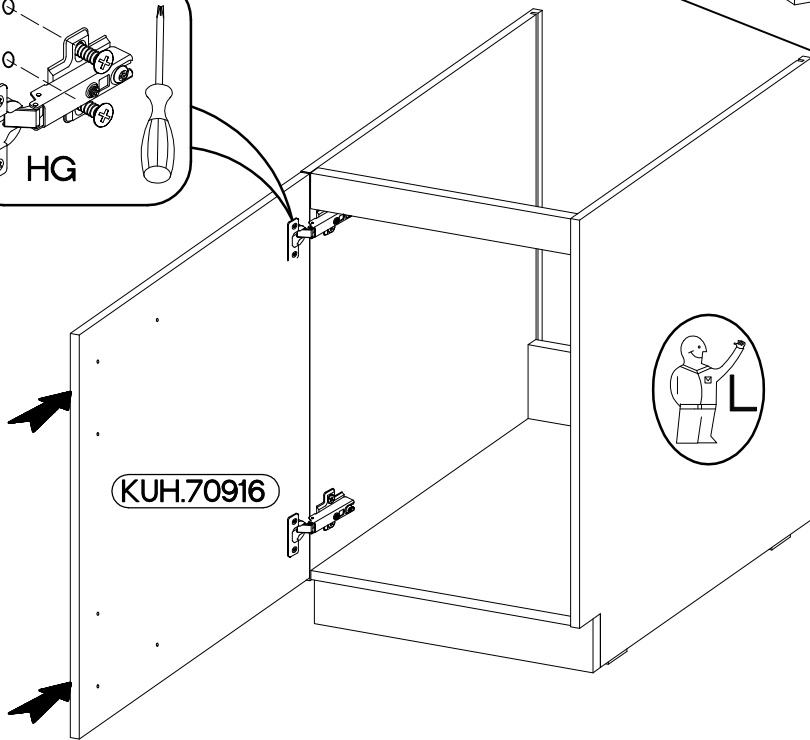
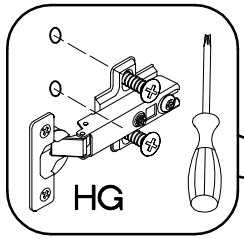
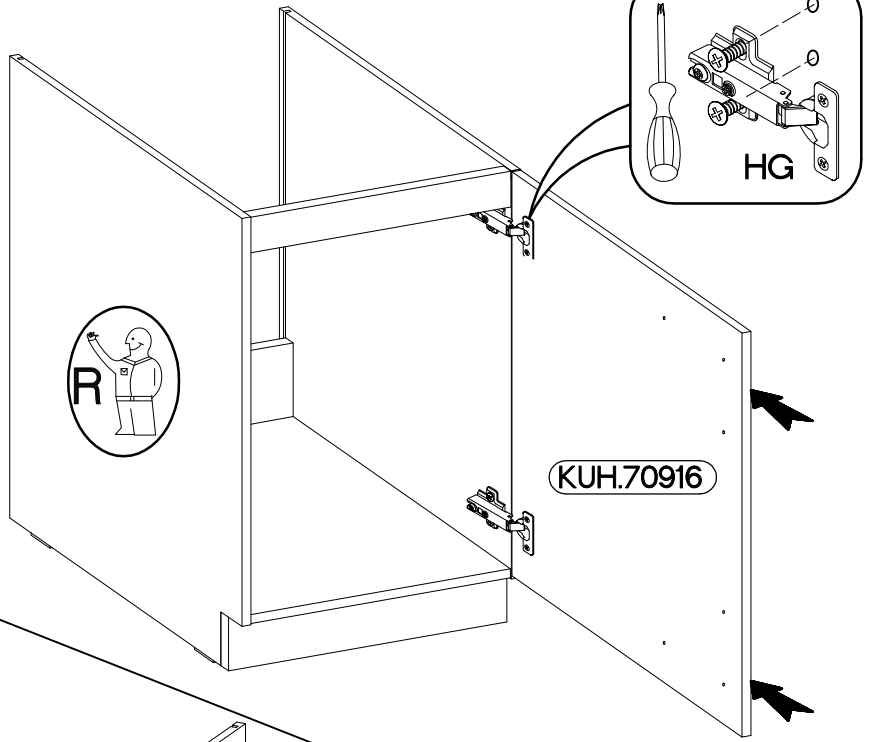

VARIANT HIGH GLOSS

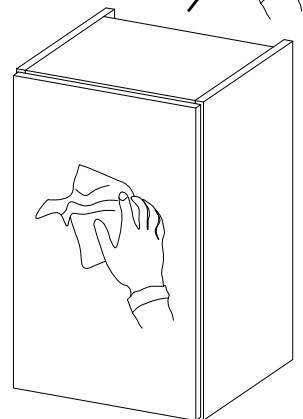
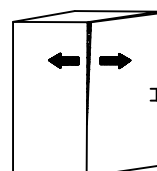
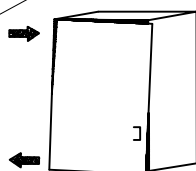
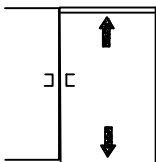
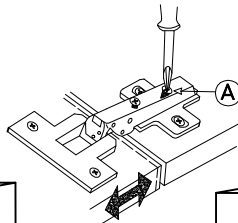
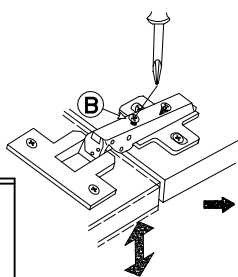
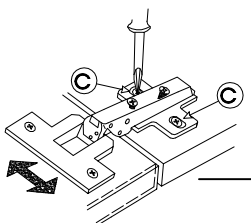
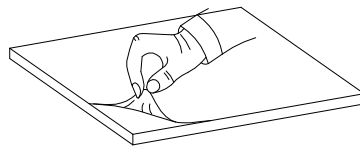
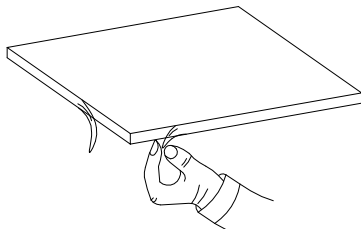

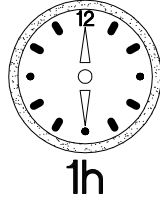
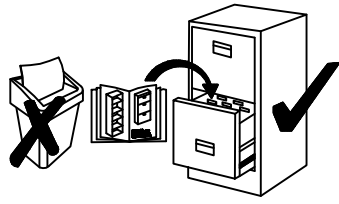
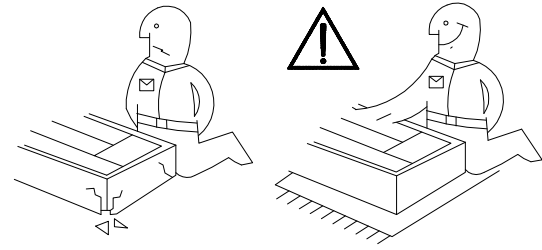
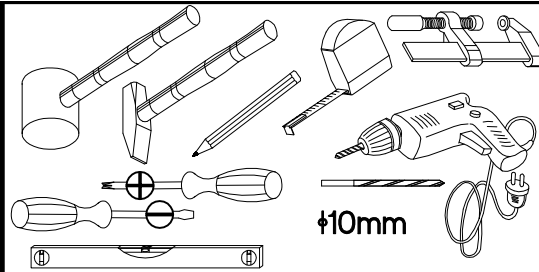
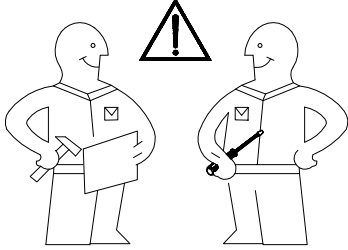

50 G-72 1F

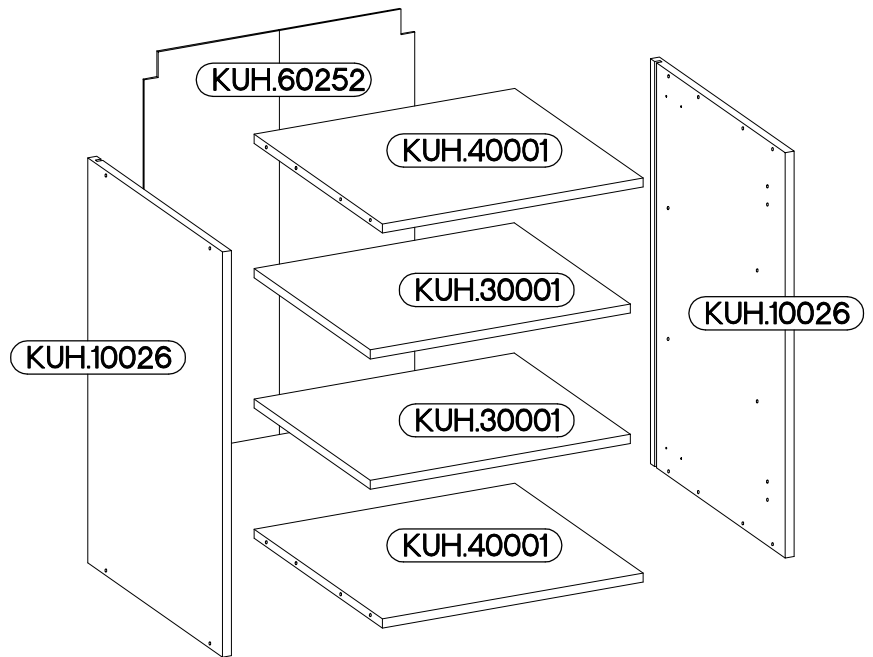
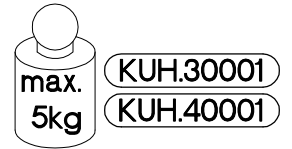
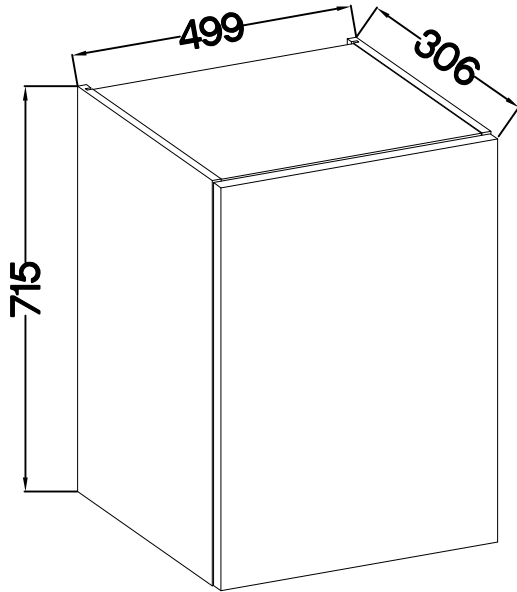
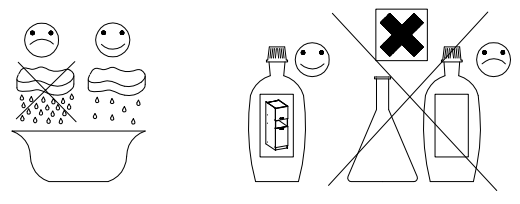

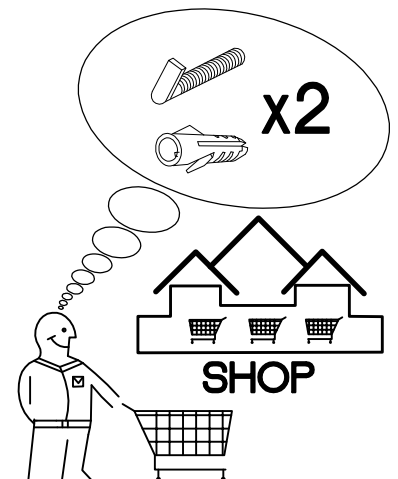

8x30mm A 8	6,4 x 50mm B 8	 E1 8	35/0mm HG 2
5/19mm J 8	 K 2	 O 1	3.5x13mm P5 4
			3.0x20mm P7 8-10
			4.0x30mm P8 4

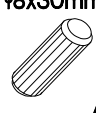

ISM-KUH-01617

1

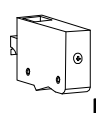
 ø8x30mm A	 ø4.0x30mm P8	 K
8	4	2

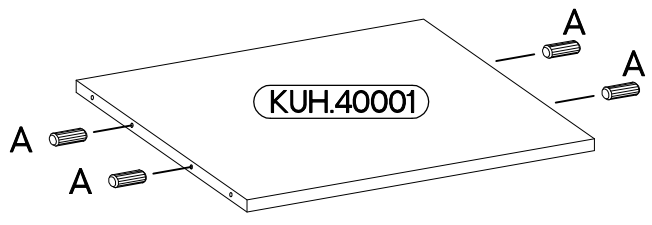
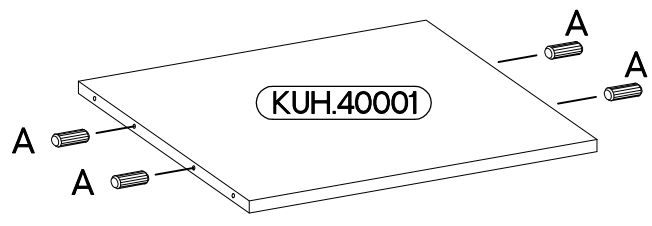
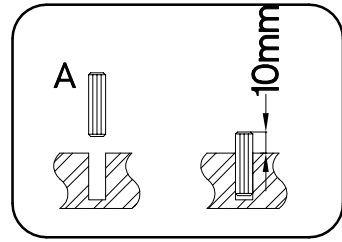
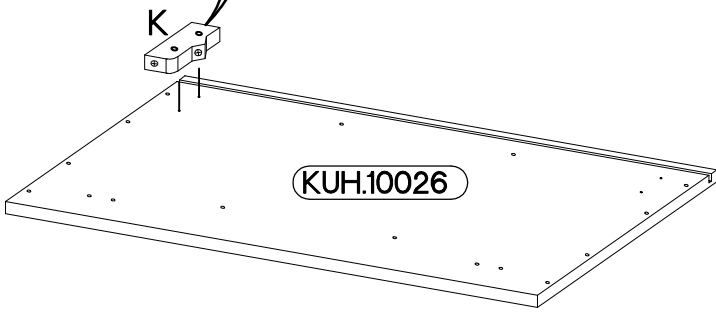
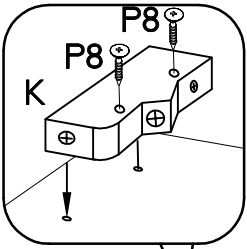
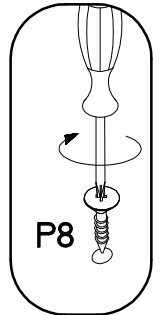
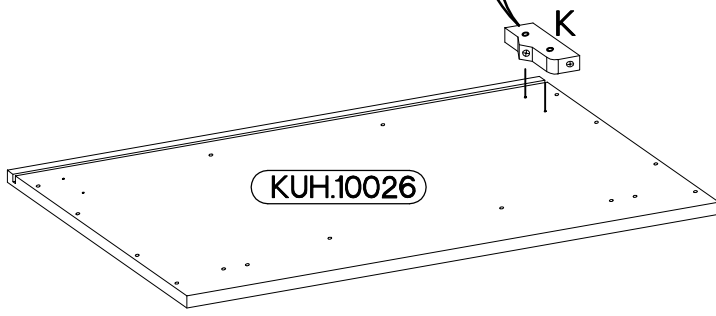
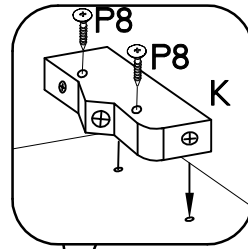
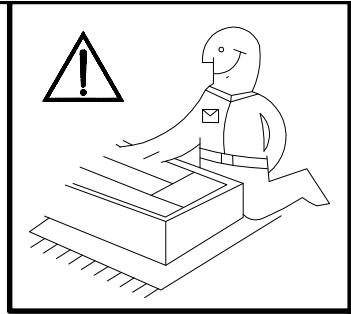

2

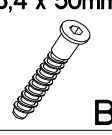
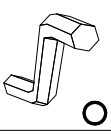
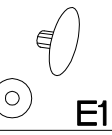
6,4 x 50mm		
		
B	O	E1
4	1	4

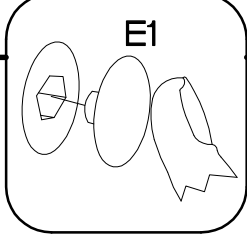
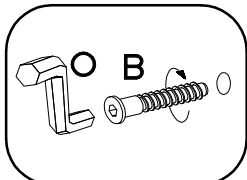
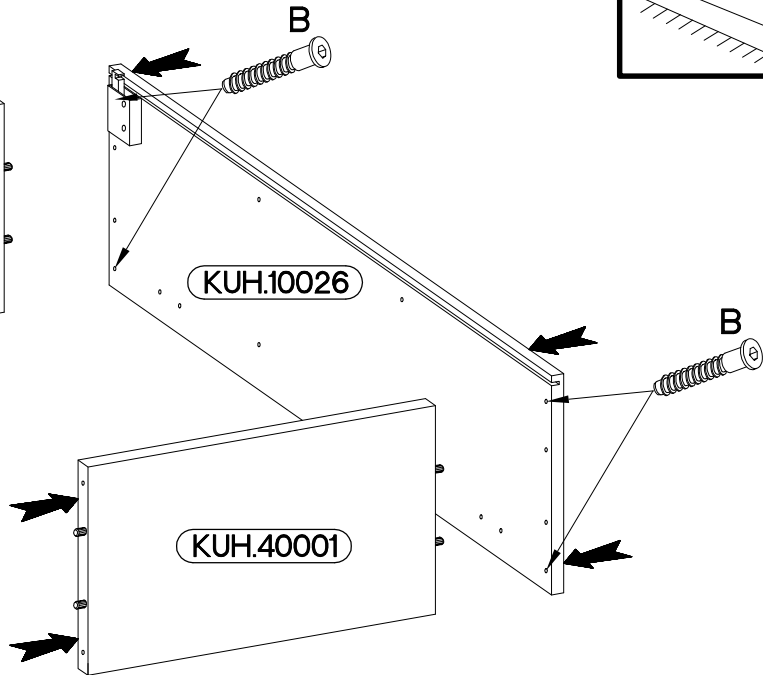
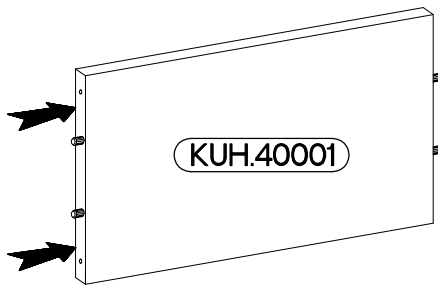
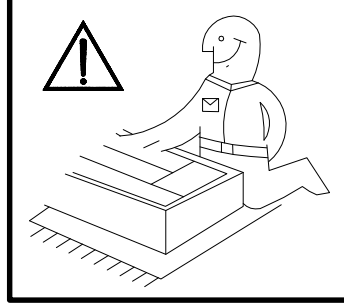

3

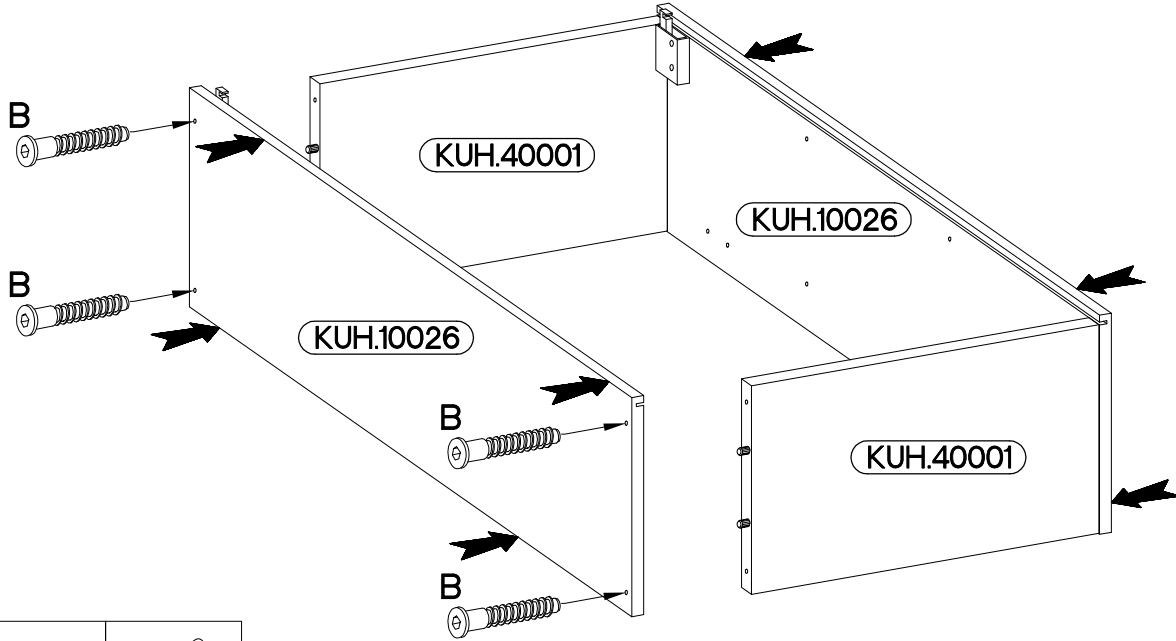

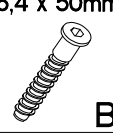
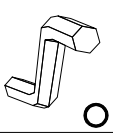
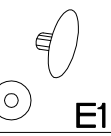
6,4 x 50mm		
		
B	O	E1
4	1	4

4

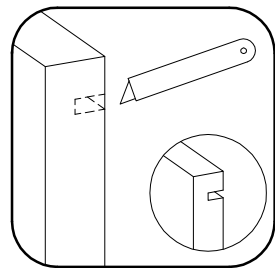
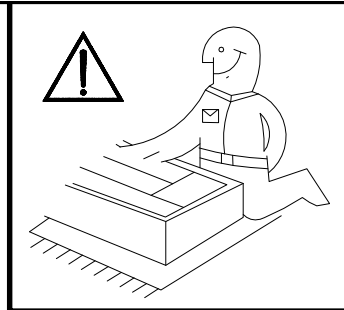
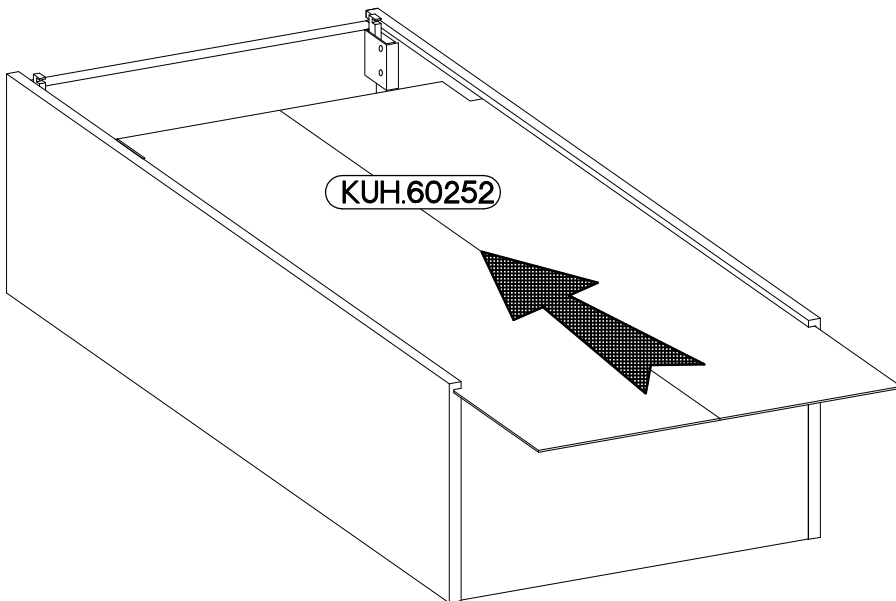

5

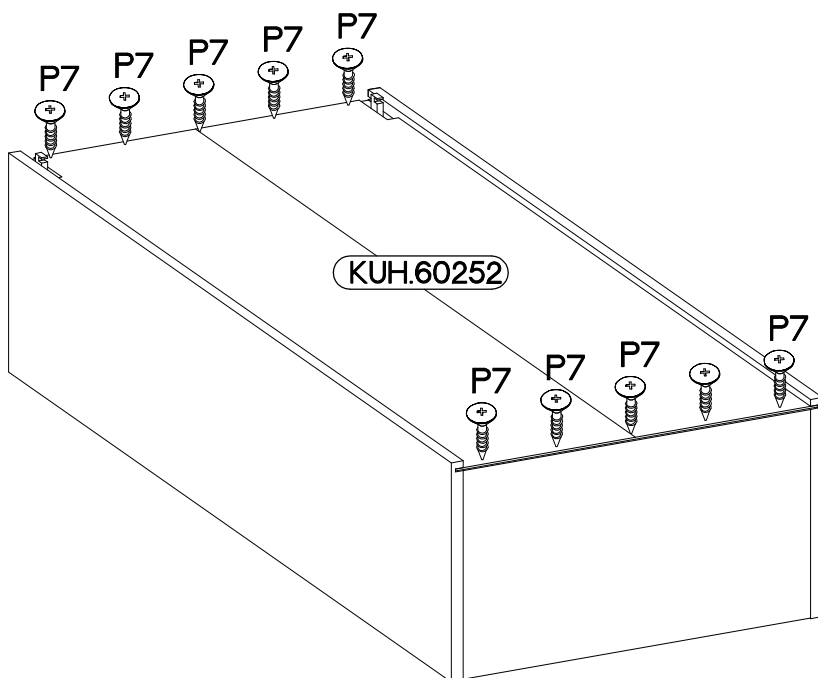
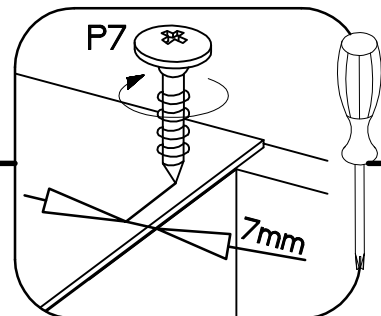
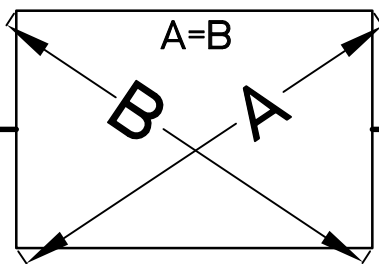
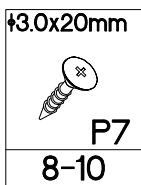

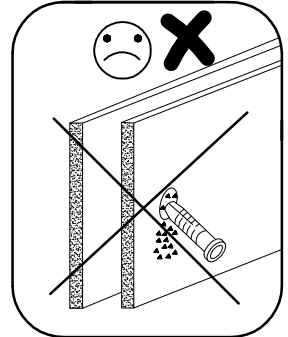
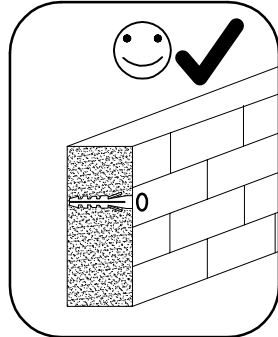
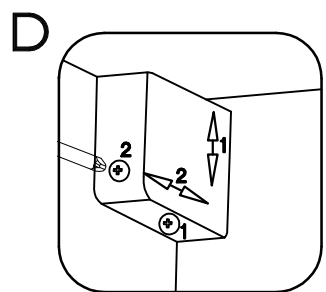
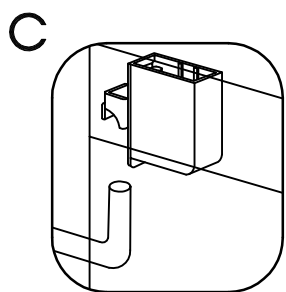
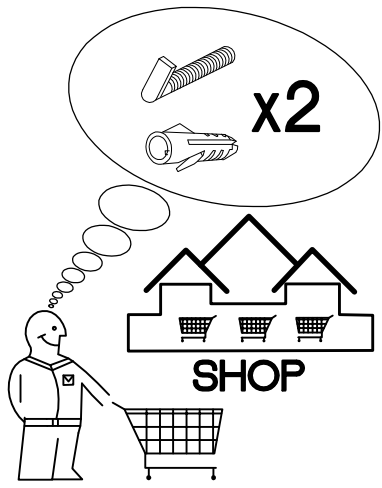
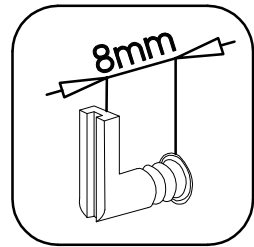
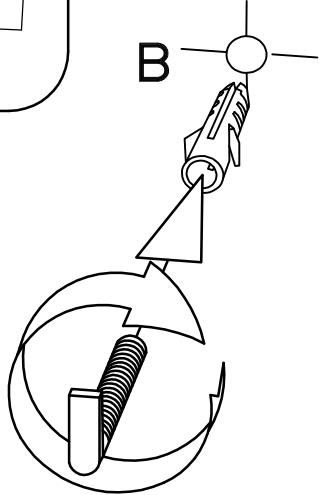
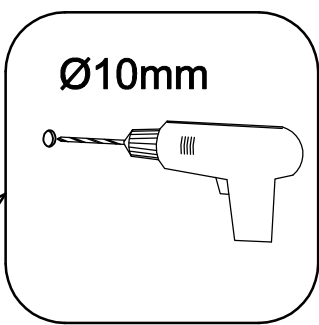
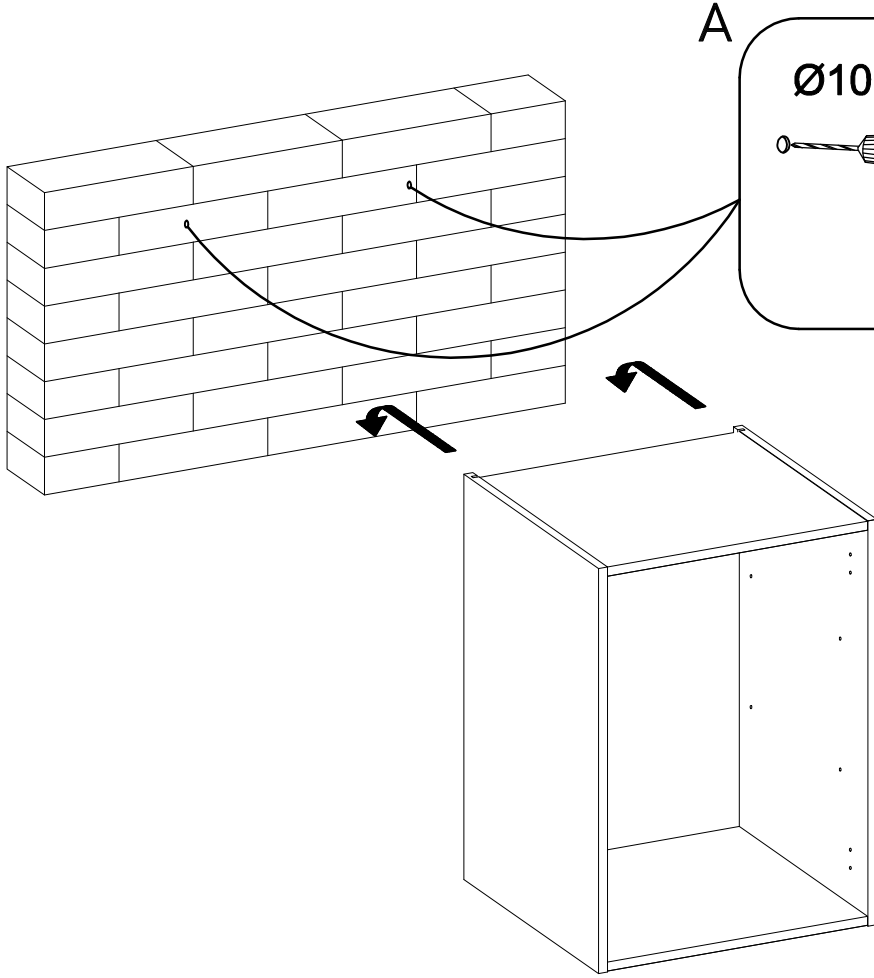
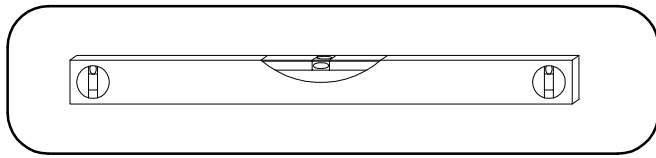

7

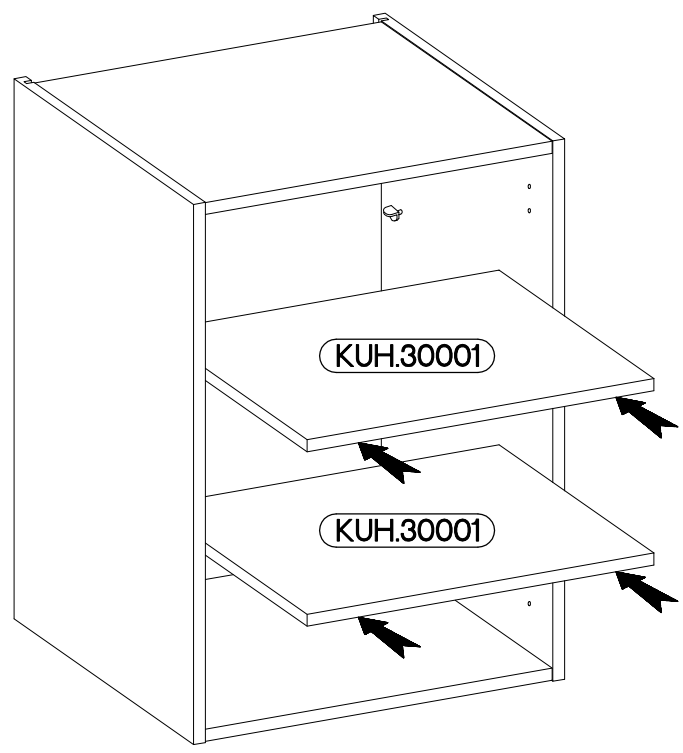
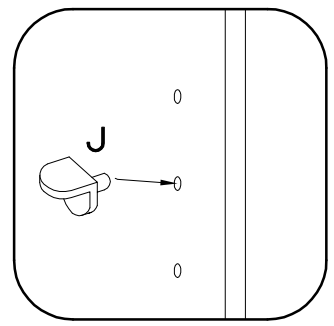
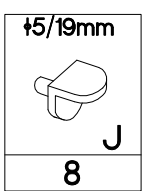

8

FRONT

