

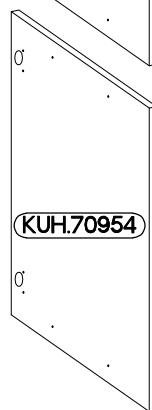

0.5h

40 DK-2100 2F
FRONT

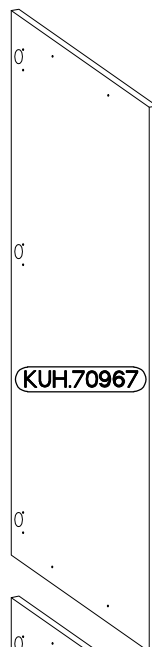
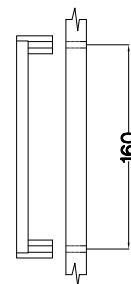
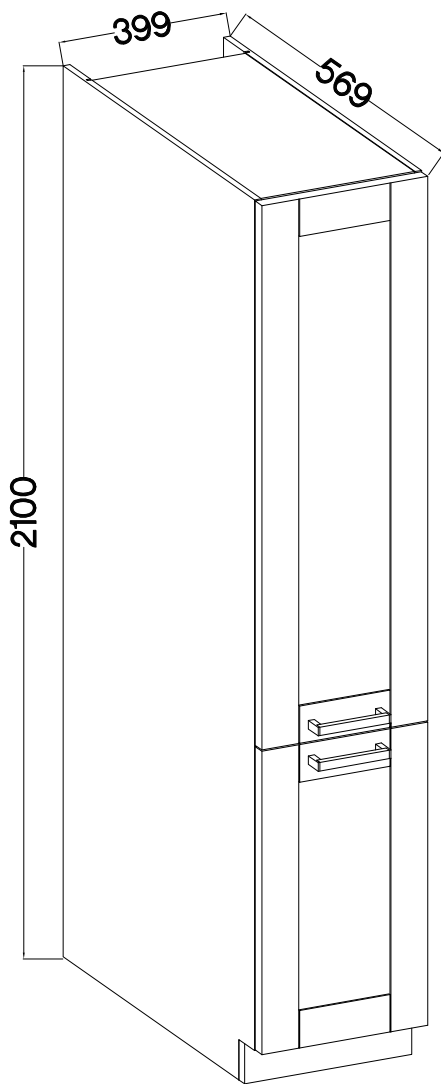
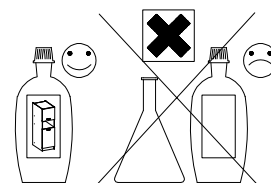

	M4x27mm
	U8
S	U8
2	4

Ersatzteil Nummer	Dimension
KUH.70954	713x396x19
KUH.70967	1280x396x19

ISM-KUH-01669

1

LEFT

RIGHT

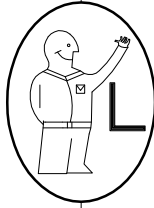
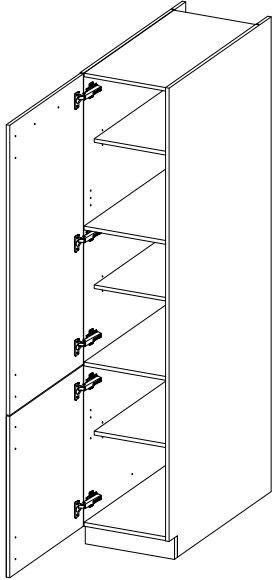
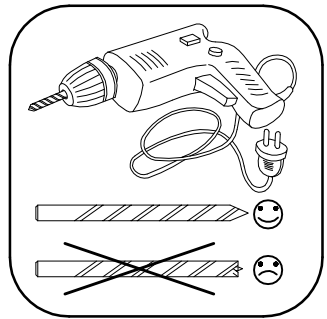

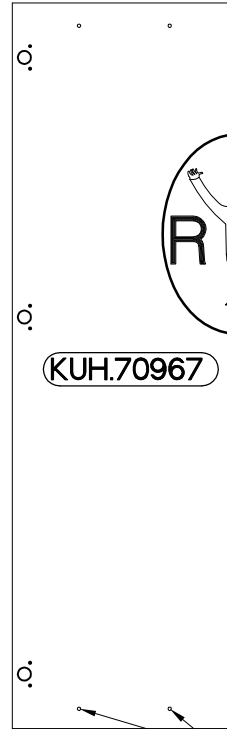

KUH.70967



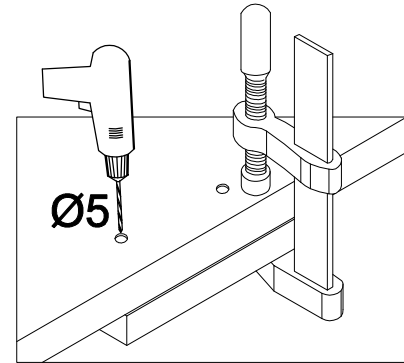
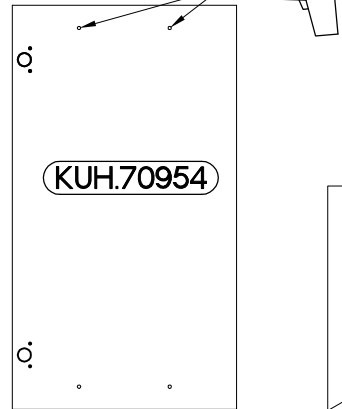
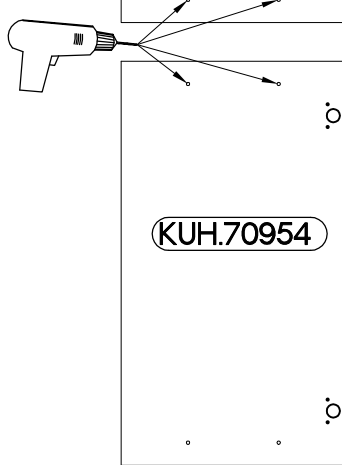
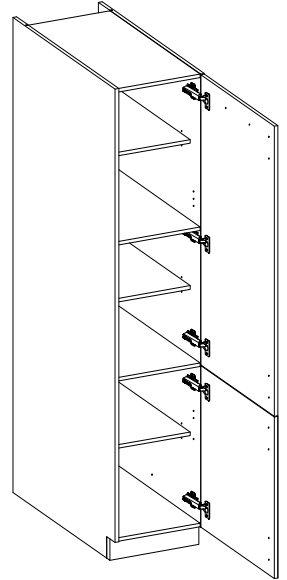

KUH.70967

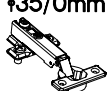

2

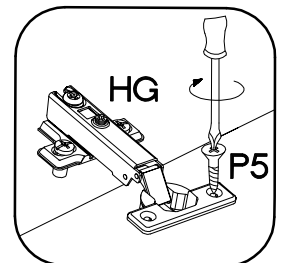
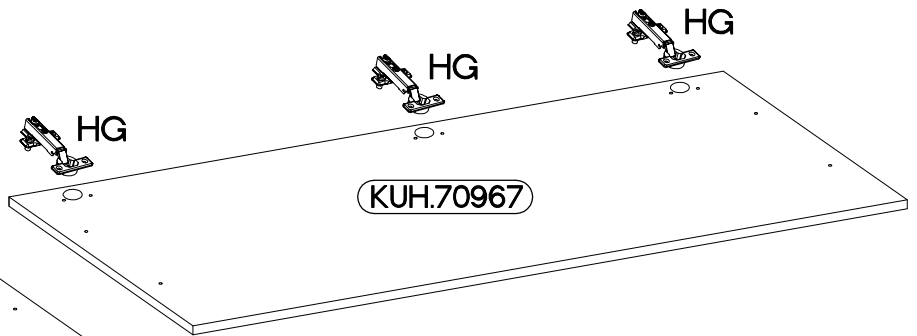
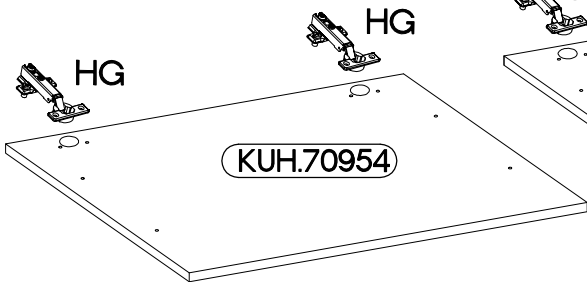
±35/0mm  HG 5	±3.5x13mm  P5 10
---	--



M4x27mm	
	
S	U8
2	4

